

SECTION 5. INFRASTRUCTURE AND SERVICES

The infrastructure, utilities, and public services to be provided as part of the development of the Esperanza Specific Plan are discussed in this section.

5.1 CIRCULATION

The circulation plan for Esperanza reinforces the objectives of providing a traditional neighborhood design. In addition to providing safe and efficient movement of vehicular traffic through the project, the Circulation Plan also provides a safe environment for pedestrian movement and bicycle traffic reducing the reliance on the automobile as a means of travel. In addition, transit stops and bus turnouts will be provided as required by Omnitrans, along the Master Plan streets, which are a part of the Esperanza community. The “Master Circulation Plan,” Exhibit 10 establishes the hierarchy and general location of roadways within Esperanza.

The minimum design speeds to be used for centerline curve radii, super elevation, corner sight distance; vertical and horizontal alignment and sight distance, etc. are listed below:

Hamner Avenue	50 m.p.h.
Eucalyptus Avenue	40 m.p.h.
Bellegrave Avenue	45 m.p.h.
Mill Creek Avenue	40 m.p.h.
“A” Street	45 m.p.h.

1

5.1.1 Master Planned Roadways

The Esperanza Specific Plan is bounded on the east, south, west, and is bisected by four City of Ontario Master Plan roadways, which will provide access to and from the Specific Plan area. Additional rights of way may be needed

at critical intersections to accommodate additional left and right turn lanes pursuant to the recommendations of the traffic study prepared for the Ontario Ranch. Hamner Avenue bounds the Specific Plan area to the east and is the county line between San Bernardino and Riverside Counties; Bellegrave Avenue bounds the Specific Plan area to the south and is also the county line between San Bernardino and Riverside Counties; Mill Creek Avenue bounds the Specific Plan area to the west, and Eucalyptus Avenue bisects the Specific Plan area in an east/west direction.

Where the Specific Plan limits extend to the centerline of any roadway, the development project shall construct the full half-width street improvement, plus a 14-foot travel lane with a 5-foot paved shoulder beyond the centerline. If the roadway includes a raised median, the project shall construct the full median, and the additional 14-foot travel lane with a 5-foot paved shoulder. The 14-foot travel lane is a minimum that may be increased as necessary pursuant to the requirements of the City Engineer.

5.1.1.1 Hamner Avenue

Hamner Avenue abuts the Specific Plan area on the east. Hamner Avenue is a designated Divided Arterial Parkway 1-1 roadway with a total right-of-way of 148 feet. Hamner Avenue will carry regional traffic to and from Esperanza and will provide access to the specific plan area along the eastern boundary of the specific plan area. Exhibit 11, “Hamner Avenue” illustrates the improvements for Hamner Avenue. The developer of the Specific Plan area adjacent to Hamner Avenue will be responsible for all on site improvements for the westerly half of Hamner Avenue as determined by the City Engineer and pursuant to the mitigation measures identified in the EIR and the Conditions of Approval established on the approved tentative maps for the project. Bus turnouts will be

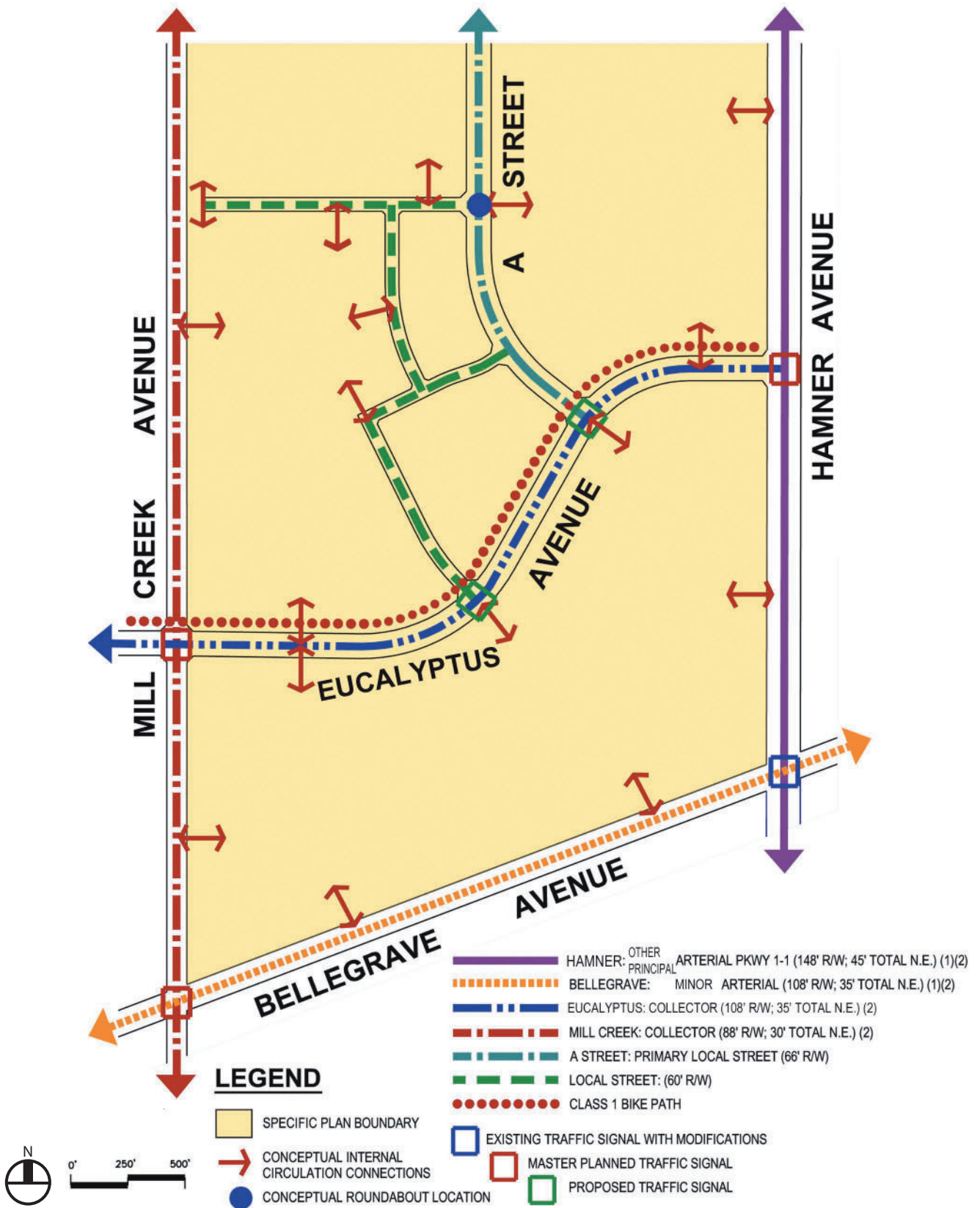

NOTE (1): SOUTH SIDE BELLEGRAVE AVENUE AND EAST SIDE HAMNER AVENUE IMPROVEMENTS ARE EXISTING IN RIVERSIDE COUNTY
 NOTE (2): N.E. = NEIGHBORHOOD EDGE

Exhibit 10
 Master Circulation Plan

required along Hamner Avenue to the satisfaction of the City Engineering Department and Omnitrans. Parking will be prohibited on Hamner Avenue.

5.1.1.2 Bellegrave Avenue

Bellegrave Avenue, a Standard Arterial roadway, abuts the Specific Plan area on the south and carries regional east/west traffic to and from Esperanza. Improvements to the south side of Bellegrave Avenue currently exist. Exhibit 12, “Bellegrave Avenue” illustrates the half-street improvements for Bellegrave Avenue. The developer will be responsible for all on site improvements for the northerly half of Bellegrave Avenue. Phasing of the improvements will be determined by the City Engineer and pursuant to the mitigation measures identified in the EIR and the Conditions of Approval established on the approved tentative maps for the project. Bus turnouts will be required along Bellegrave Avenue to the satisfaction of the City and Omnitrans.

5.1.1.3 Mill Creek Avenue

Mill Creek Avenue abuts the Specific Plan area on the west. Mill Creek Avenue is a designated Collector Street with an ultimate right-of-way of 88 feet, with 64 feet of paved area and a 12-foot parkway on each side of the street, to include a 5-foot sidewalk separated from the street by a 7-foot landscaped area. In addition a landscaped buffer of 18 feet in width will be provided between the back of the sidewalk and the residential community wall. The right-of-way improvements required to Mill Creek Avenue are illustrated in Exhibit 13, “Mill Creek Avenue.” The developer(s) will be responsible for the off site improvements as determined by the City Engineer and pursuant to the mitigation measures identified in the EIR and the Conditions of Approval established on the approved tentative maps for the project. Bus turn-

outs will be required along Mill Creek Avenue to the satisfaction of the City and Omnitrans. Parking will be prohibited on Mill Creek Avenue. Exhibit 13, “Mill Creek Avenue” illustrates these improvements.

5.1.1.4 Eucalyptus Avenue

Eucalyptus Avenue bisects the Specific Plan area and is designated as a Standard Arterial roadway. Exhibit 14, “Eucalyptus Avenue” illustrates the Eucalyptus Avenue full-street improvements. The developer will be responsible for all improvements to Eucalyptus Avenue. The phasing of these improvements will be determined by the City Engineer and pursuant to the mitigation measures identified in the EIR and the Conditions of Approval established on the tentative maps for the project. Parking will be prohibited on Eucalyptus Avenue.

5.1.2 Local Streets and Alleys

Within the Specific Plan area neighborhood streets of varying design will provide access and circulation through the community. Many of the neighborhoods will be served by private alleys, which are located in the rear of residences, in order to maintain a traditional, “architecture forward” streetscape for the community. Public and private local streets within residential areas are designed to distribute vehicular traffic from the public arterial and collector streets adjacent to the Specific Plan area into and through residential neighborhoods. Local streets and private alleys proposed for Esperanza are illustrated on Exhibit 15, “A Street” – Primary Local Street” Exhibit 16, “Local Streets and Cul-De-Sac Sections;” Exhibit 17, “Private Neighborhood Streets;” and Exhibit 18, “Private Alley and Drive Aisle Sections;” and discussed below.

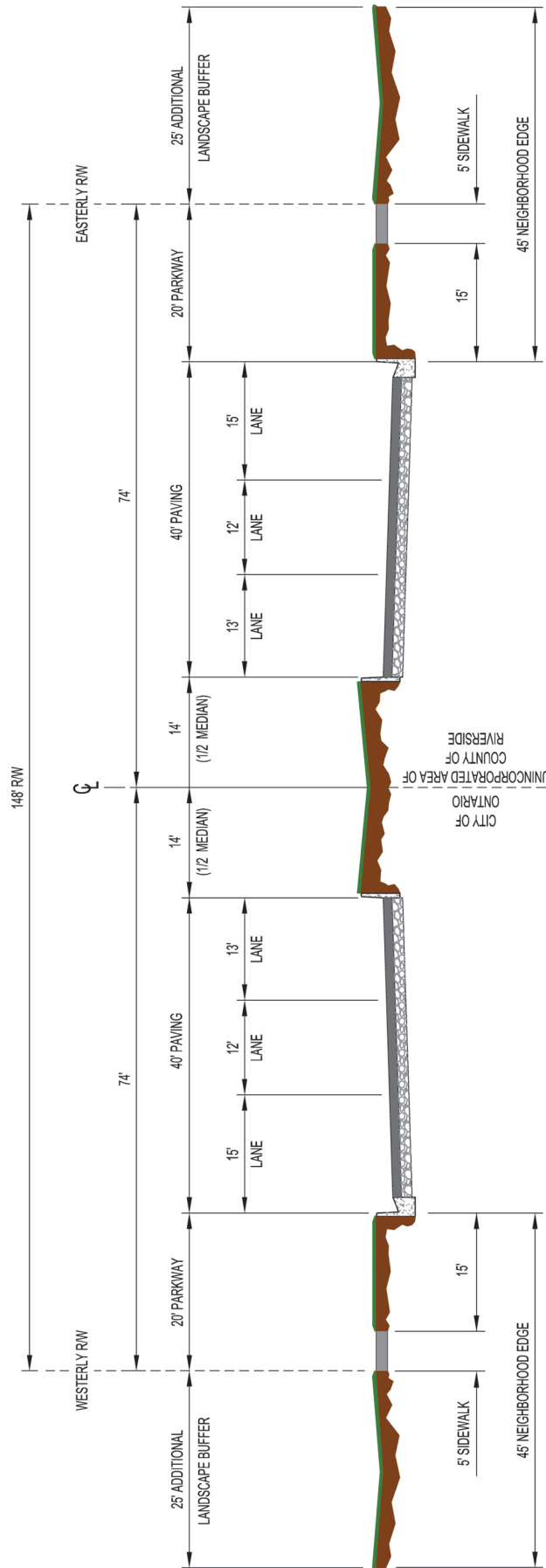

Other Principal Arterial Parkway 1-1
Hamner Avenue
 (On Street Parking is Prohibited)

Exhibit 11
 Hamner Avenue

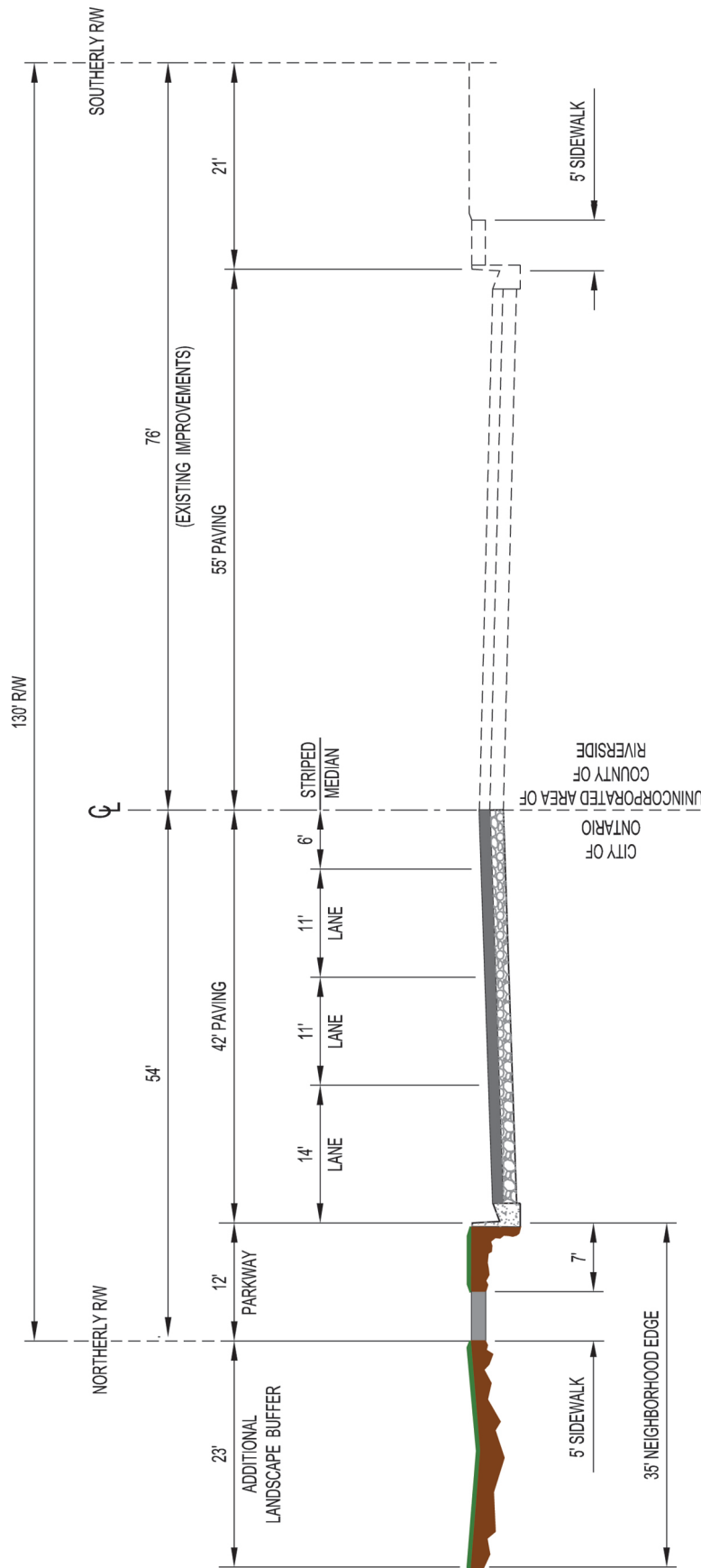

Minor Arterial
Bellegrave Avenue
 (On Street Parking is Prohibited)

Note: Final required level of improvement of Bellegrave Avenue within the City of Ontario to be determined by City of Ontario and Riverside County.

Exhibit 12
 Bellegrave Avenue

5.1.2.1 “A Street”

“A Street” bisects the Specific Plan area in a north/south direction and is designated as a Primary Local Street. “A Street” will provide internal access and connectivity between residential areas and the Neighborhood Park and school site. Exhibit 15, “A Street” – Primary Local Street” illustrates the improvements planned for “A Street.”

5.1.2.2 Local Neighborhood Streets and Cul-De-Sac Streets

A network of local public neighborhood streets and cul-de-sac streets will provide internal circulation throughout Esperanza for residents. Exhibit 16, “Local Streets and Cul-de-sac Sections” illustrates these street concepts.

5.1.2.3 Private Neighborhood Streets

Private neighborhood streets will provide internal circulation within single family attached and single family courtyard product areas. Water, recycled water, and sewer utilities may be designated as “public utilities” if located within public or private streets. All public utilities within private streets shall be designed per City standards and contained within acceptable easements. The CC&Rs for the project shall contain language requiring all work proposed by the HOA within such easements to be plan checked and inspected by the City, including applicable fees. Generally, utilities will not be accepted as public within alleys, parking areas or driveways. The extent to which said utilities will be accepted as public utilities shall be at the full discretion of the City during final design review. Private Neighborhood Streets planned for Esperanza are illustrated in Exhibit 17, “Private Neighborhood Streets.”

5.1.2.4 Private Alleys

Private alleys within the residential development will have a minimum of 20 feet of paved area with 5 feet of landscaping on each side. In areas where fire access is required, the minimum paved area will be 24 feet with 3 feet of landscaping on each side. Alleys with “dead end” conditions will be a maximum length of 150 feet. Parking is prohibited along alleys. Tapers will be incorporated at the point where private alleys intersect with public streets. The taper width will be determined per the approval of City of Ontario Fire Department, Engineering Department and Planning Department.

5.1.2.5 Private Drive Aisles

Private drive aisles are planned with a total paved width of 24 feet and an 18 foot deep parking area on each side.

Water, recycled water, and sewer utilities may be designated as “public utilities” if located within public or private streets. All public utilities within private streets shall be designed per City standards and contained within acceptable easements. The CC&Rs for the project shall contain language requiring all work proposed by the HOA within such easements to be plan checked and inspected by the City, including applicable fees. Generally, utilities will not be accepted as public within alleys, parking areas or driveways. The extent to which said utilities will be accepted as public utilities shall be at the full discretion of the City during final design review. Private Alleys and Private Drive Aisles planned for Esperanza are illustrated in Exhibit 18, “Private Alley and Drive Aisle Sections.”

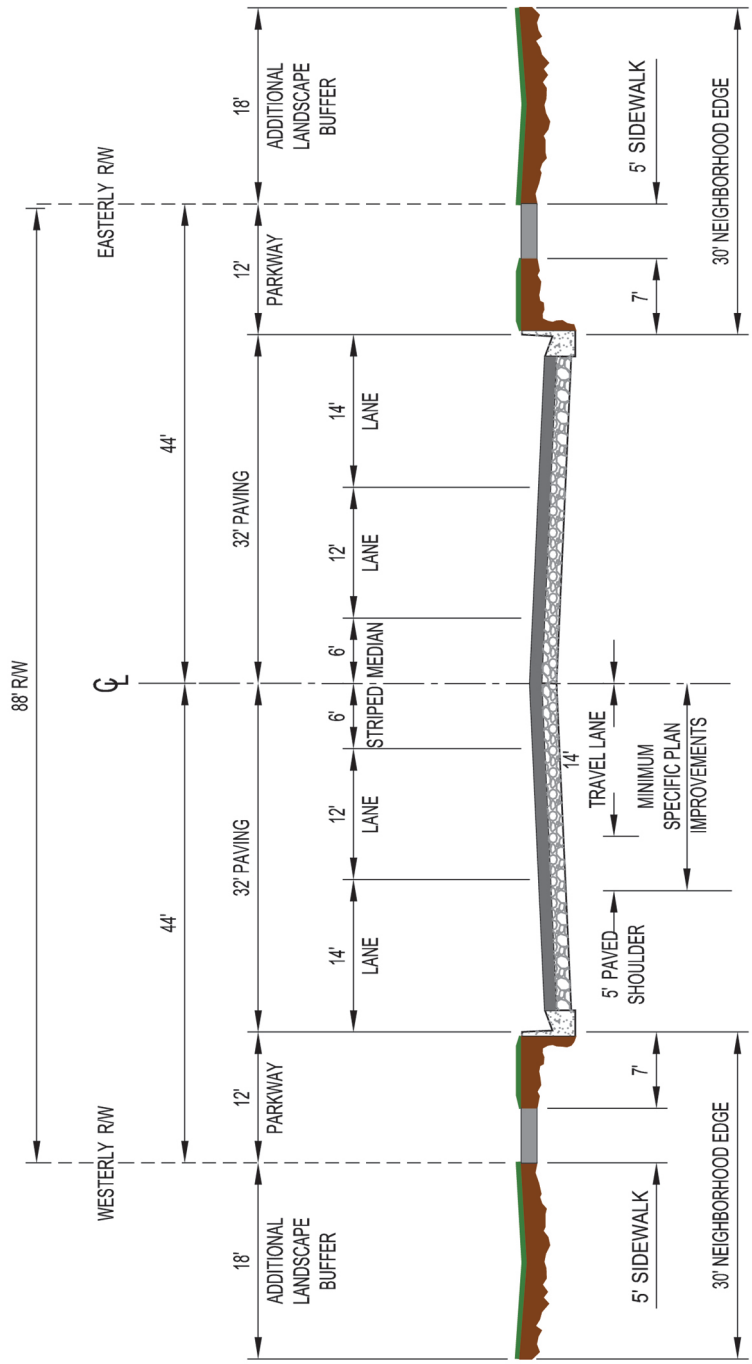

Collector
Mill Creek Avenue
 (On Street Parking is Prohibited)

Exhibit 13
 Mill Creek Avenue

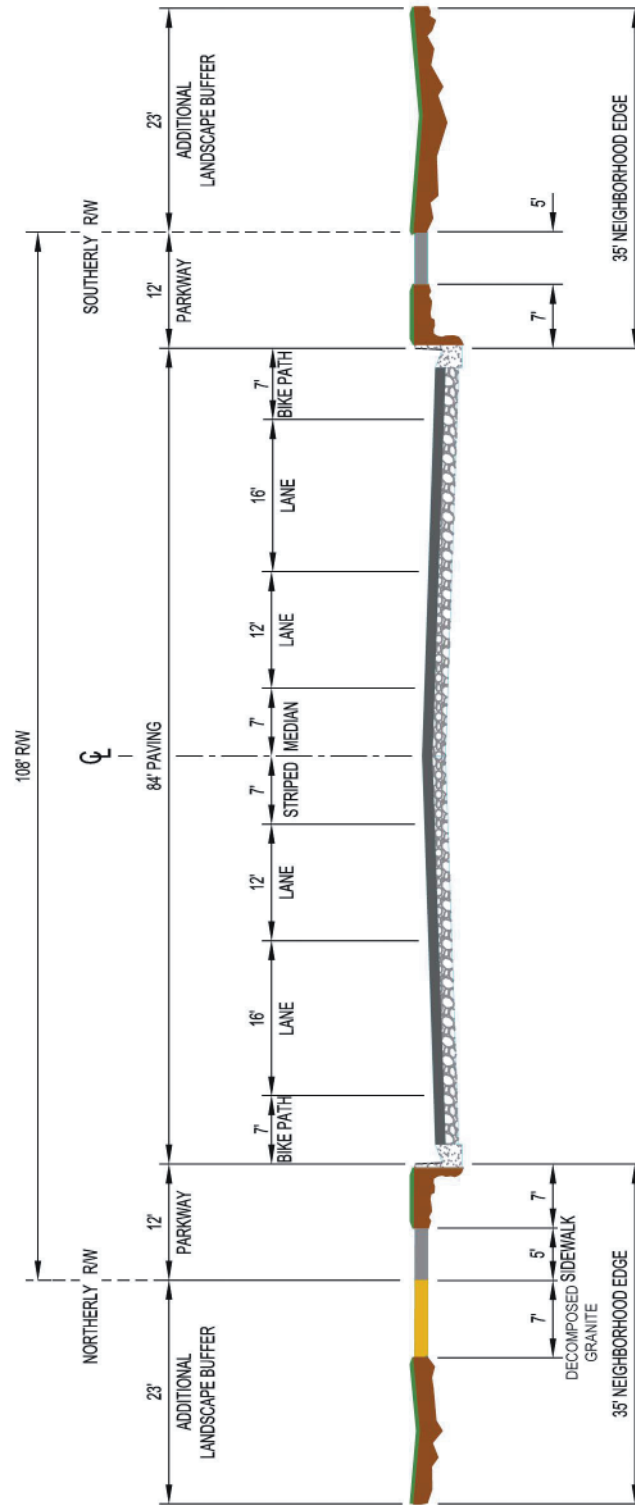

Collector
Eucalyptus Avenue
 (On Street Parking is Prohibited)

Exhibit 14
 Merrill Avenue⁵

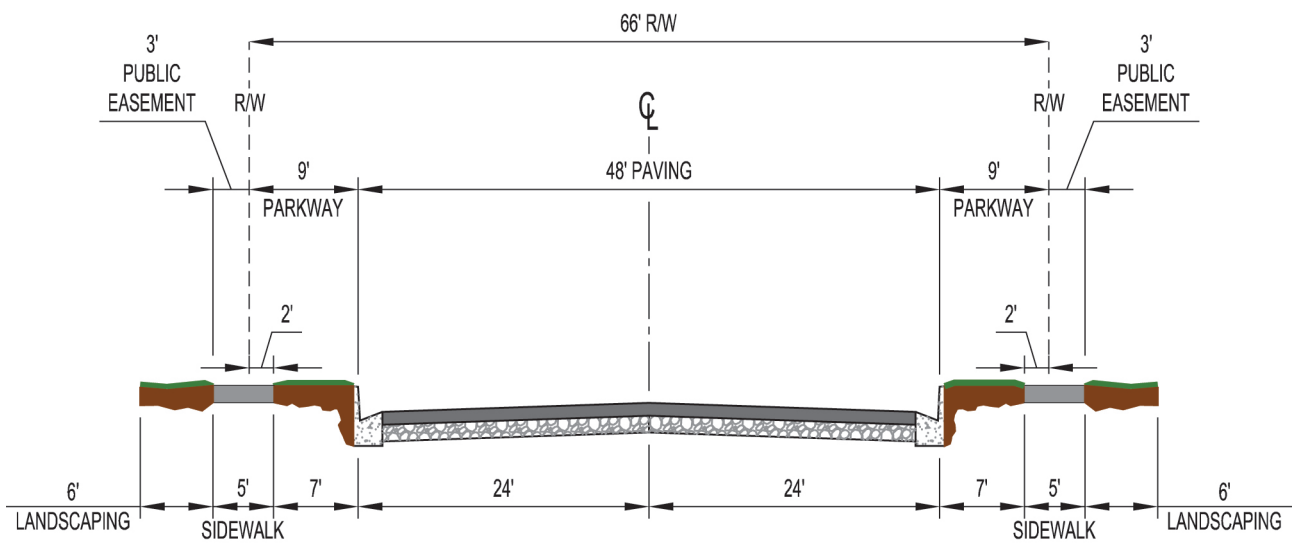

"A Street"
(Parking Permitted)

Exhibit 15
"A Street" – Primary Local Street

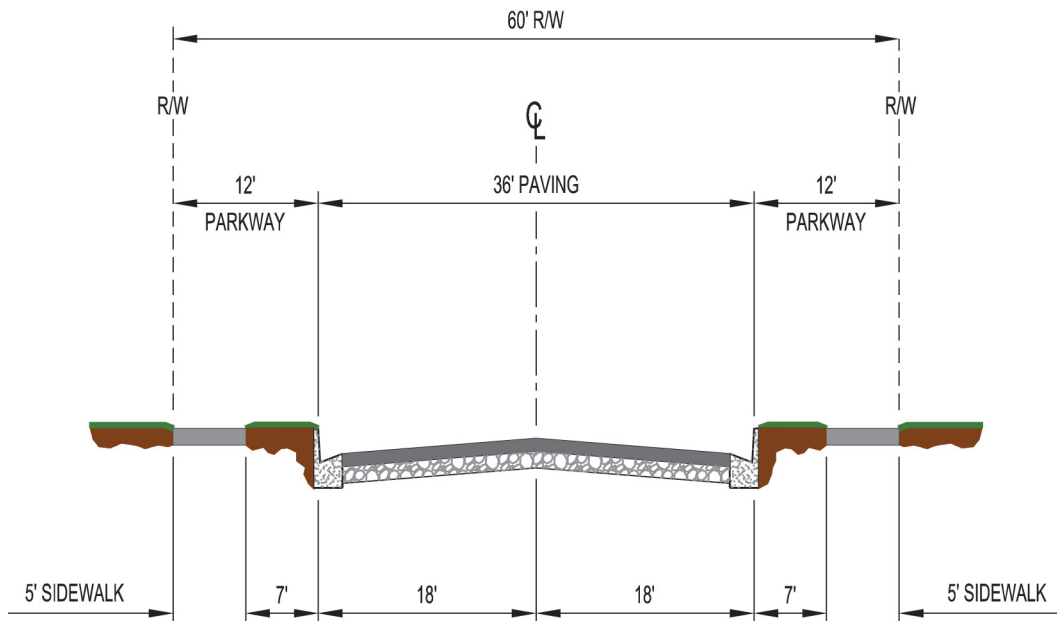

Note: Parking may be restricted within 100-150 feet of Merrill Avenue, A' Street, Mill Creek Avenue and Hammer Avenue Intersections.

Exhibit 16
Local Streets and Cul-De-Sac Sections

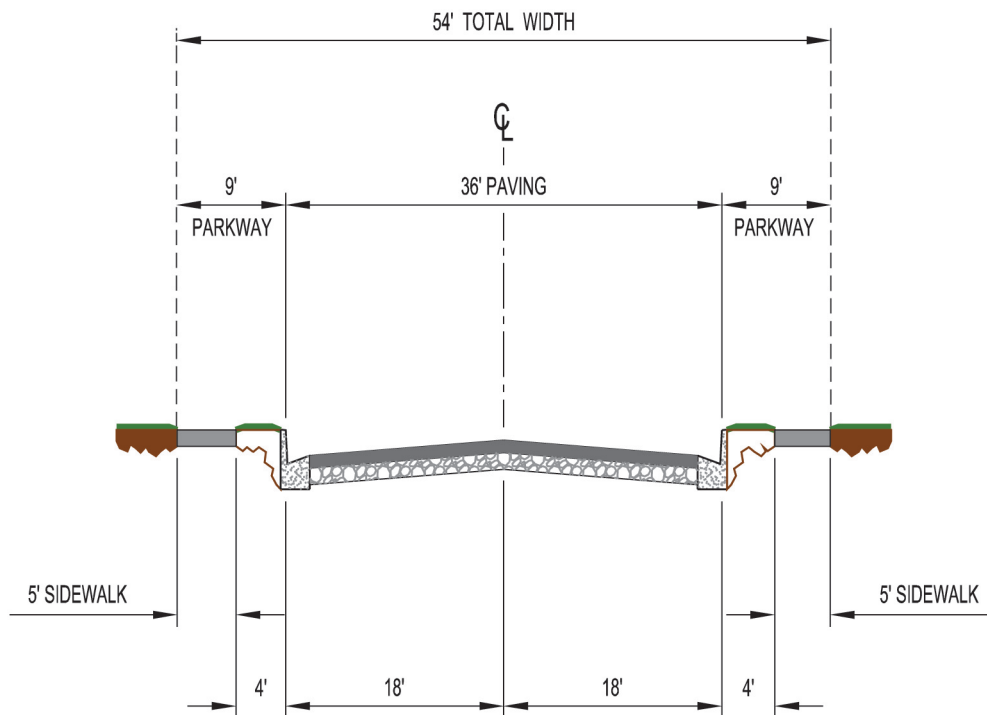

Private Neighborhood Streets
 (Located in Planning Areas 1, 3, 4 & 5)

Note: All public utilities within private streets shall be designed per City standards and contained within acceptable easements. The extent to which said utilities will be accepted as public utilities shall be determined at the full discretion of the City during final design review.

Exhibit 17
 Private Neighborhood Streets

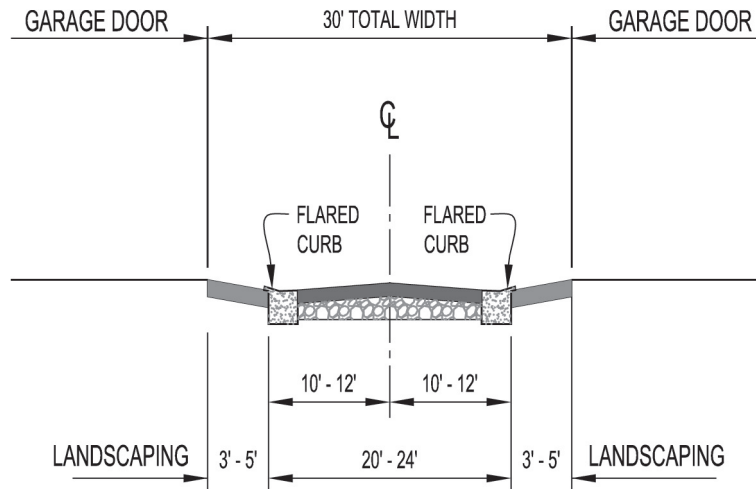

Private Alley
(On Street Parking is Prohibited)

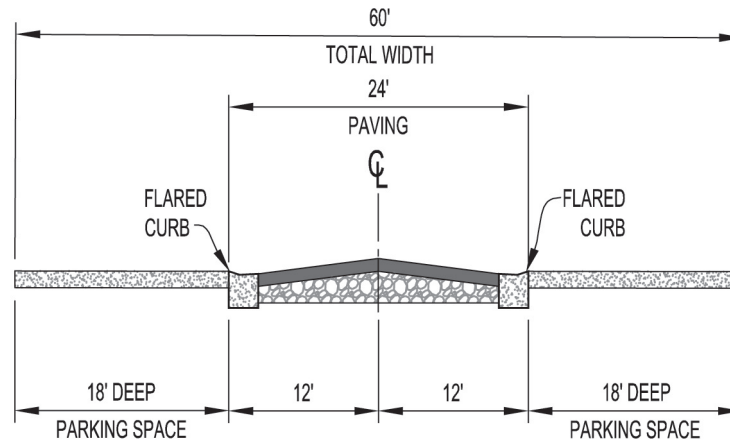

Private Drive Aisle

Notes:

1. *Final Alley Design is subject to approval by the City Engineer, Fire Department and Planning Department.*
2. *All public utilities within private streets shall be designed per City standards and contained within acceptable easements. The extent to which said utilities will be accepted as public utilities shall be determined at the full discretion of the City during final design review.*

Exhibit 18
Private Alley and Drive Aisle Sections

5.1.3 Traffic Calming

The Esperanza Specific Plan includes design features within residential neighborhoods to encourage drivers to proceed slowly and reduce traffic noise on streets contributing to safe and livable neighborhoods in which to walk, bike, and drive.

Traffic calming within the Esperanza Specific Plan is designed to address the following goals:

- Reduction in traffic speeds.
- Reduction in traffic related noise.
- A safe and pedestrian friendly circulation system to encourage walking.

The following design features will be implemented in the roadways within Esperanza.

Local Neighborhood Street Design

Neighborhood streets within Esperanza are designed in a “modified grid” with landscaping on either side within parkways to add interest in the street encouraging drivers to slow their travel speed and observe their surroundings. Incorporating tapered intersections for local streets as illustrated in Exhibit 19, “Neighborhood Street Tapers,” may reduce traffic speeds on local residential streets.

Alleys Tapers

Private alleys within Esperanza will consist of 20-24 feet of paved travel area with 3-5 feet of landscaping on each side. Speeds for traffic entering the alleys and cut through traffic can be reduced by incorporating tapers at the entrance to these alleys as illustrated on Exhibit 20, “Alley Tapers.”

Landscaping

Landscaping adjacent to streets within the Specific Plan area will combine the use of shade trees, shrubs, and groundcover adjacent to sidewalks to create a more intimate streetscape encouraging drivers to reduce driving speeds. The landscape concept for Esperanza is designed to contribute to a sense of the street system as a pedestrian protected area to promote slower traffic speeds.

Roundabouts

A roundabout will be incorporated into the street design at the intersection of two local streets as illustrated in Exhibit 10, “Master Circulation Plan.” The use of a roundabout rather than a conventional all-way stop at this intersection will maintain traffic flow by requiring traffic entering the roundabout to yield to traffic traveling within the roundabout. The lack of a stop sign allows entering traffic to merge with the flow of traffic.

5.1.4 Pedestrian Circulation

Off-street pedestrian circulation will be available throughout Esperanza by means of the interconnected, paved sidewalk system within the roadway right-of-way, separated from vehicular travel lanes by a landscaped parkway. The Esperanza pedestrian system provides connectivity among residential neighborhoods to the Neighborhood Park, pocket parks, and the elementary school within the Specific Plan area.

5.1.5 Bicycle Trails

Bicycle trails are an integral element to creating accessibility and mobility within Esperanza. A Class 1 bike trail will be provided within the parkway on the north side of Eucalyptus Avenue and an on-street bike trail will be provided on both sides of Eucalyptus Avenue connecting to

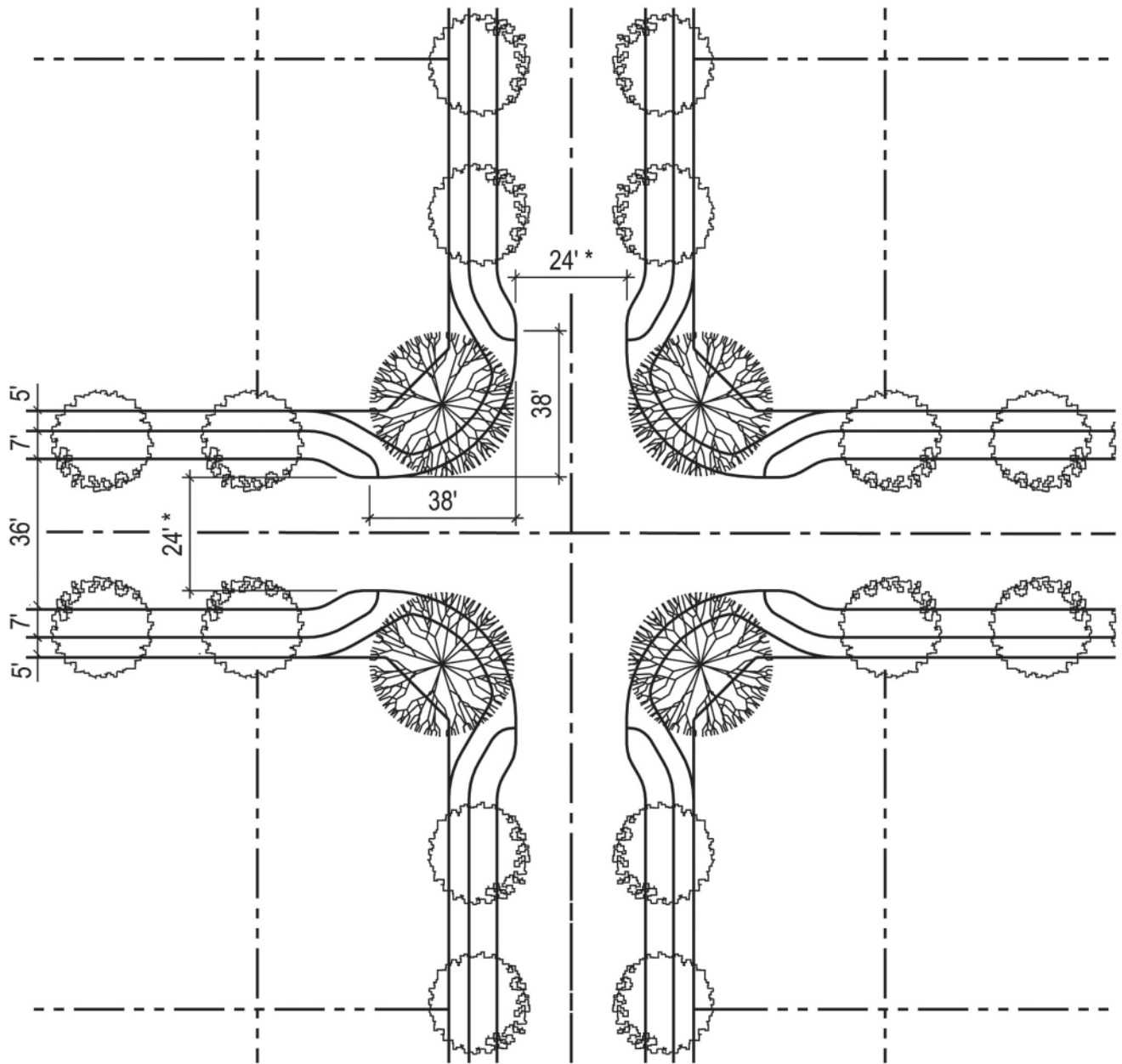

* (TAPER WIDTHS SUBJECT TO PLANNING, ENGINEERING,
& FIRE DEPARTMENT APPROVAL)

Exhibit 19
Neighborhood Street Tapers

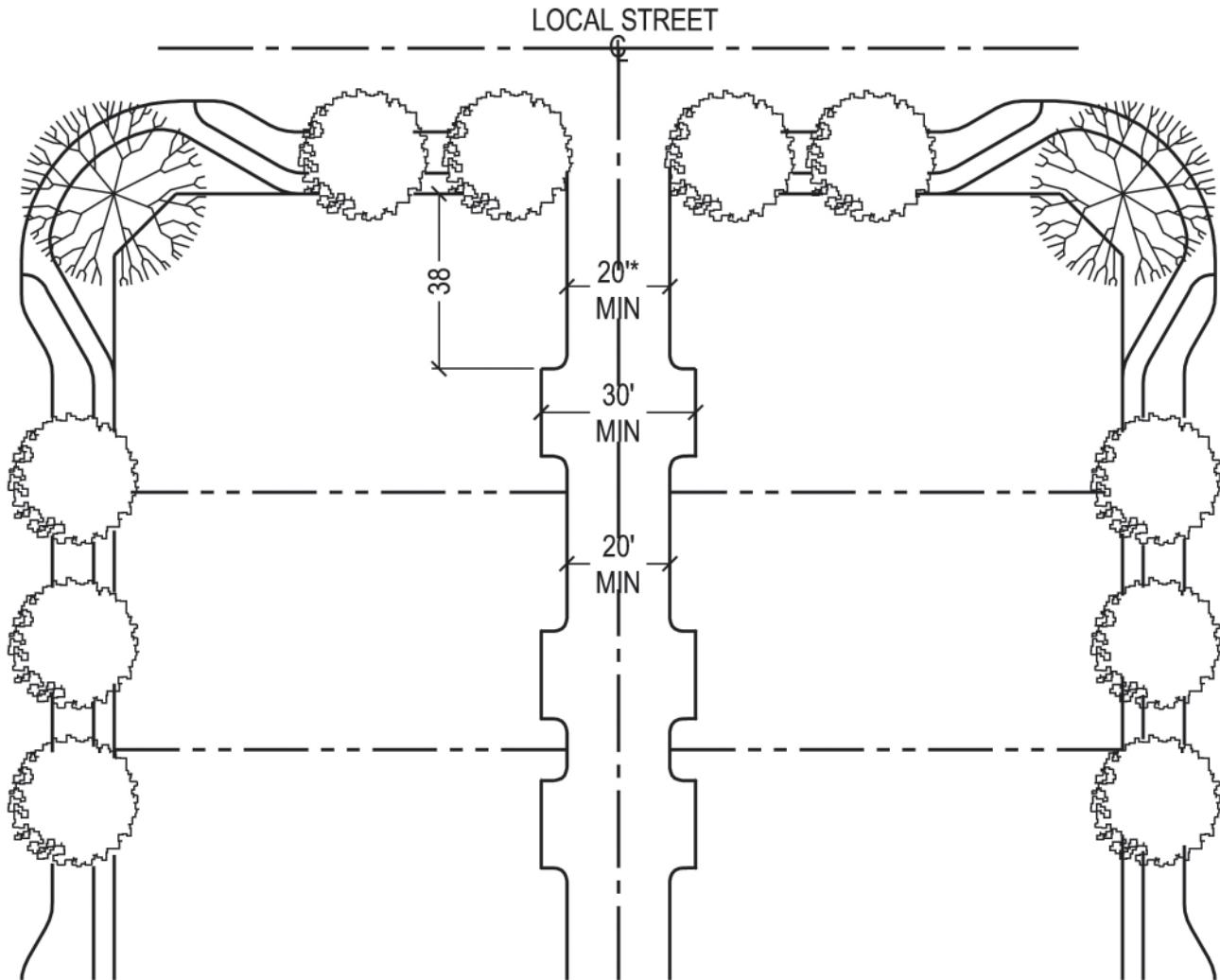

(*) TAPER WIDTHS ARE SUBJECT TO PLANNING, ENGINEERING, & FIRE DEPARTMENT APPROVAL

Exhibit 20
Alley Tapers

Section 5. INFRASTRUCTURE AND SERVICES



Exhibit 21
Pedestrian and Bicycle Circulation Plan

on-street bike trails provided on local residential streets within the Specific Plan to connect all residential neighborhoods to one another, to the Neighborhood Park and to the elementary school located toward the center of the Specific Plan boundary.

Class II on-street striped bike lanes shall be provided on roadways within the Esperanza Specific Plan area as determined by City Engineer.²

The Master Plan for pedestrian and bicycle circulation for Esperanza is illustrated on Exhibit 21, “Pedestrian and Bicycle Circulation Plan.”

5.2 DOMESTIC AND RECYCLED WATER MASTER PLAN

Domestic water will be provided by the City of Ontario. The Ontario Ranch Water Master Plan Phase 1 (Phases 1a–1d) identifies new water facilities to include one reservoir, three groundwater wells and potable and reclaimed transmission water lines. Construction of the on site and off site Master Plan water service improvements shall be the responsibility of the developer(s) and is required prior to issuance of building permits for Esperanza. Two of the waterlines included in the Phase 1 improvements are a 24 inch water line in Hamner Avenue, adjacent to the site on the east, and a 24-inch water main in Eucalyptus Avenue, which goes through the center of the project.

5.2.1 Domestic Water

The project lies within the 925 Zone. New domestic water mains to be constructed as part of the development of Esperanza will include a 12-inch Master Plan water main in Mill Creek Avenue, from the northerly boundary of the Specific Plan to Eucalyptus Avenue. Within the Specific Plan area, a network of 8-inch and 12' inch water lines will be installed. The On Site

water system will include connections to two different transmission mains.

The City is in the process of updating the Water Master Plan. Any changes resulting from the updated Master Plan will be incorporated into the Esperanza Water Master Plan.

There are two groundwater wells located adjacent to Bellegrave Avenue to the north. These wells and water transmission lines in Bellegrave Avenue, are owned and operated by the Chino Basin Desalter Authority (CDA). As part of the development of the Specific Plan area, improvements shall be made, to the satisfaction of the CDA and the City of Ontario, surrounding the two existing well sites located at the north side of the ultimate right of way of Bellegrave Avenue. Improvements shall include, but are not limited to, perimeter fencing, relocation of existing utilities within the ultimate right of way, street landscaping within the right of way fronting the project, and driveway approaches. The Master Plan for domestic water for Esperanza is illustrated on Exhibit 22, “Conceptual Domestic Water Master Plan.” The conceptual on site domestic water system is illustrated on Exhibit 23 “On Site Domestic Water Plan.”

5.2.2 Recycled Water System

The Inland Empire Utilities Agency (IEUA) will ultimately provide recycled water from IEUA's RP-1 and RP-1 outfall parallel located in Carpenter Avenue via City of Ontario recycled water mains as presented in the Water Master Plan for the Ontario Ranch. The Specific Plan area is located within the 930 Zone. The construction phase source of recycled water to serve the Specific Plan area will be conveyed to the 930 Zone from the 1050 Zone via a Master Plan pressure reducing station located in Archibald Avenue north of Chino Avenue. The master planned recycled water mains to be constructed

as part of the development of Esperanza will include the following:

- A 12-inch recycled water line in Mill Creek Avenue from the northerly boundary of the Specific Plan area to Eucalyptus Avenue.
- An 8-inch recycled water line in Hamner Avenue from the northern boundary of the Specific Plan area to Eucalyptus Avenue.
- An 8-inch recycled water line in Eucalyptus Avenue from Hamner Avenue to Mill Creek Avenue.
- A 12-inch line in Eucalyptus Avenue from Mill Creek Avenue to Haven Avenue.
- A 16-inch line in Eucalyptus Avenue from Haven Avenue to Archibald Avenue.
- A 16-inch line in Archibald Avenue from Eucalyptus Avenue to Edison Avenue.
- A 20-inch line in Archibald Avenue from Edison Avenue to Schaefer Avenue.
- A 36-inch line in Archibald Avenue reducing to a 24-inch line from Schaefer Avenue to Chino Avenue.
- Utilization of the existing 10-inch main which extends from the IEUA facility adjacent to Westwind Park to the intersection of Archibald Avenue and Schaefer Avenue.

The developer will provide all recycled water lines required to serve the Specific Plan area.

Within the Specific Plan area, 8-inch recycled water mains are proposed to serve the development. The City's goal is to maximize the use of recycled water including but not limited to irrigation of parks, schools, street landscaping, recreation trails, common area residential landscaping and commercial/industrial landscaping edges. The parks, school, and landscaped areas that will be irrigated with recycled water and the calculated recycled water demand are contained in the report titled, "Esperanza Water and Recycled Water Hydraulic Analysis." An Engineer's Report approved by the City and

the Department of Health is required prior to the use of recycled water.

The conceptual Master Plan for recycled water for Esperanza is illustrated on Exhibit 24, "Conceptual Recycled Water Plan." The conceptual on site recycled water system is illustrated on Exhibit 25, "Conceptual On Site Recycled Water System."

5.3 SEWER MASTER PLAN

Sewer service for Esperanza will be provided by the City of Ontario. The City's Sewer Master Plan identifies ultimate sewer facilities from the Specific Plan area to the Eastern Trunk Sewer. These Master Planned facilities include a 15-inch sewer main extending from the northerly boundary of the Specific Plan area, along Mill Creek Avenue increasing to a 21-inch sewer main at Eucalyptus Avenue and a 24 inch sewer main along Bellegrave Avenue westerly to the Master Planned Eastern Trunk Sewer. Completion of these Master Plan improvements is required to provide the ultimate sewer service to Esperanza. Within the Specific Plan area a network of 8-inch and 15-inch sewer lines will be installed. The sizing and alignment of all off-site sewer improvements necessary for mitigation of impacts shall follow the results of the approved Sanitary Sewer Technical Study.³

The Conceptual Sewer Master Plan for Esperanza is illustrated on Exhibit 26, "Sewer Master Plan." The conceptual on site sewer lines are illustrated on Exhibit 27, "Conceptual On Site Sewer."

5.4 DRAINAGE

The City's Storm Drain Master Plan identifies new storm drain facilities to serve the Specific Plan area extending northerly from the County Line Channel within Mill Creek Avenue. Completion of these Master Plan improvements

will provide permanent storm drain service to Esperanza.

That portion of the Master Planned line, which lies within Esperanza, will be constructed as a part of the development of the project. These improvements include a 90-inch storm drain in Mill Creek Avenue transitioning to a 102-inch storm drain, connecting to the County Line Channel.

On site storm drains will be constructed to convey the on site flows to the proposed Master Planned storm drain line in Mill Creek Avenue. The locations and size of on site storm drains within Esperanza will be established in accordance with City requirements as part of the approval by the City of Ontario of tentative tract maps for the Esperanza Specific Plan area.

The Drainage Master Plan for Esperanza is illustrated in Exhibit 28, “Storm Drain Master Plan.” The size and location of the proposed storm drain may change based on the final design.

5.4.1 NPDES Compliance

The grading and drainage of the Esperanza Specific Plan area shall be designed to detain, filter and treat surface runoff, in a manner and combination which is practical, to comply with the most recent requirements of the San Bernardino County NPDES Storm Water Program’s Quality Management (WQMP) for significant new development projects. The objective of the WQMP for this project is to minimize the detrimental effects of urbanization on the beneficial uses of receiving waters, including effects caused by increased pollutants and changes in hydrology. These effects may be minimized through the implementation of site designs that reduce runoff and pollutant transport by minimizing impervious surfaces and maximizing on-site infiltration, Source Control Best

Management Practices (BMP’s) and/or either on-site Structural Treatment Control BMP’s, or participation in regional or watershed-based Treatment Control BMP’s.

Prior to the issuance of a grading or construction permit, a Storm Water Pollution Prevention Plan (SWPPP) will also be prepared. The SWPPP will be prepared to comply with the California State Water Resources Control Board’s (State Water Board) current, “General Permit to Discharge Storm Water Associated With Construction Activity” and the current Area Wide Urban Storm Water Runoff (Regional NPDES Permit). The SWPPP will identify and detail all appropriate Best Management Practices (BMP’s) to be implemented or installed during construction of the project.

In addition to the preparation of a SWPPP for construction-related activities, and as part of the approval of any grading plans within the Specific Plan Area, the applicant will be required to submit a Water Quality Management Plan (WQMP) on the regional model form provided by the City. The WQMP shall identify and detail all Site Design BMP’s, Source Control BMP’s and Treatment Control BMP’s to be implemented or installed at this site in order to reduce storm water pollutants and site runoff.

An off site regional stormwater runoff treatment facility with capacity to accept and treat drainage from portions of the Specific Plan Area has been constructed. This regional treatment facility will be part of an overall solution for storm water treatment within this planned development area. Projects with reserved treatment capacity allocation in the regional facility will utilize this off-site facility as their primary BMP for addressing urban runoff water quality and hydro-modification impacts, in their respective WQMPs. If a project cannot obtain treatment capacity in the regional stormwater treatment facility, alter-

native on-site or off-site Low Impact Design BMBs will be required based on the most current MS4 Permit requirements.⁴

5.5 SCHOOLS

The Mountain View School District is the school district serving the K-8 school needs of Esperanza. The Chaffey Joint Union High School District serves the 9-12 school age needs of the Specific Plan area. Additional elementary, middle, and high schools are needed to serve the needs of school age children within the Ontario Ranch. An elementary school site has been proposed within the Esperanza Specific Plan and a middle school site has been proposed in Planning Subarea 24. Colony High School is located at the southwest intersection of Mill Creek Avenue and Riverside Drive and a future high school has been proposed in Planning Subarea 23. Development of the Esperanza Specific Plan area will generate an estimated student population as follows (based on student generation numbers supplied by the City of Ontario, “School Generation for Ontario Ranch Subareas,” July 2, 2004. The developer(s) of Esperanza will be required to pay school fees as required by State of California.

Grades K- 5
Generation Factor 0.38/D.U.
$0.38 \times 1594 = 606$
Grades 6-8
Generation Factor 0.22/D.U.
$0.22 \times 1594 = 351$
Grades 9-12
Generation Factor 0.20/D.U.
$0.20 \times 1594 = 319$

5.6 PUBLIC UTILITIES

5.6.1 Natural Gas

The Gas Company will provide natural gas to the Specific Plan area. Gas mains will be installed to the Specific Plan area by the Gas Company as necessary.

5.6.2 Electricity

Southern California Edison will provide electricity to the Specific Plan area from existing facilities in the vicinity of the Specific Plan area. Proposed new facilities to serve the project will be owned and operated by the City of Ontario and located underground. Existing lines within the Specific Plan area shall be placed underground by developer and according to the City of Ontario adopted ordinance.

5.6.3 Telecommunications

The City of Ontario will be providing OntarioNet, fiber-to-the-home. OntarioNet is a fiber-optic telecommunications system capable of providing advanced Internet/data services to all homes and businesses within the Ontario Ranch. OntarioNet will provide community related services including: traffic management; on-line civic services; meter reading; educational services; and a variety of other community services. Based on the demographics of the Ontario Ranch and the traffic issues into Orange and Los Angeles Counties, the demand for telecommuting in the Ontario Ranch is anticipated to be significant. OntarioNet and the high-speed data services it provides will allow residents of the Esperanza Specific Plan to effectively telecommute to their jobs and in general provide a significant economic benefit to Ontario. Verizon currently provides telephone service within the Specific Plan area and can provide telecommunication service if they choose to do so.

5.6.4 Solid Waste

The City of Ontario provides solid waste collection services for the Ontario Ranch and

will service the Specific Plan area. The project will comply with Municipal Code Section 6-3.314, “Commercial Storage Standards” and Section 6-3.601, “Business Recycling Plan” for the use of any commercial bin service for apartment development. All residential development shall comply with Municipal Code Section 6-3.308.9 (a) and (d), “Residential Receptacles, Placement” for curbside automated container service. The project shall comply with Municipal Code Article 6, “Recycling Requirements for Specified Business Activity”, Section 6-3.601 Business Recycling Plan, and Section 6-3.602, “Construction and Demolition Recycling Plan.” All site development shall comply with the City of Ontario refuse collection standards. All project sites shall be designed to meet all the Integrated Waste Department’s requirements, including the requirements for Sizing of Storage, Location of Collection Area, Accessibility for Collection Vehicles, and Collection of Sorted/ Diverted Waster Types including Organics.

5.7 GRADING CONCEPT

The site falls at an average slope of approximately two percent (2%). The Grading Concept for Esperanza is to work with the existing topography to maintain natural grade and elevations wherever possible. The grading operation for the Specific Plan area will generally consist of the removal of any manure remaining from dairy operations, clearing and grubbing, demolition of existing structures, and moving of surface soils to construct building pads and streets. Additionally, where slope conditions are present, the property shall be located at the top of the slope. In areas adjacent to a ridgeline or in moderate slope areas, dwelling units and structures should be sited to:

- Use the natural ridgeline as a backdrop for structures;
- Use landscape plant materials as a backdrop; and

- Use structure to maximize concealment of cut slope.

If retaining walls are required, the following criteria shall be used:

- Exposed walls and fences facing roadways shall be no greater than 3-foot retaining (9-foot total wall) in height, except as necessary for acoustical purposes to satisfy the intent of the noise ordinance.
- Where retaining walls or fences face roadways, they shall be built, when feasible, of decorative materials consistent with the wall theme of the neighborhood.

The Conceptual Grading Plan, as illustrated in Exhibit 29, “Conceptual Grading Plan,” will provide for a balance of cut/fills for the site. Grading plans for each tract in the Specific Plan area will be reviewed and approved by the City of Ontario Building, Planning, and Engineering Departments prior to the issuance of grading permits. All grading plans and activities will conform to the City grading ordinance and dust and erosion control requirements.

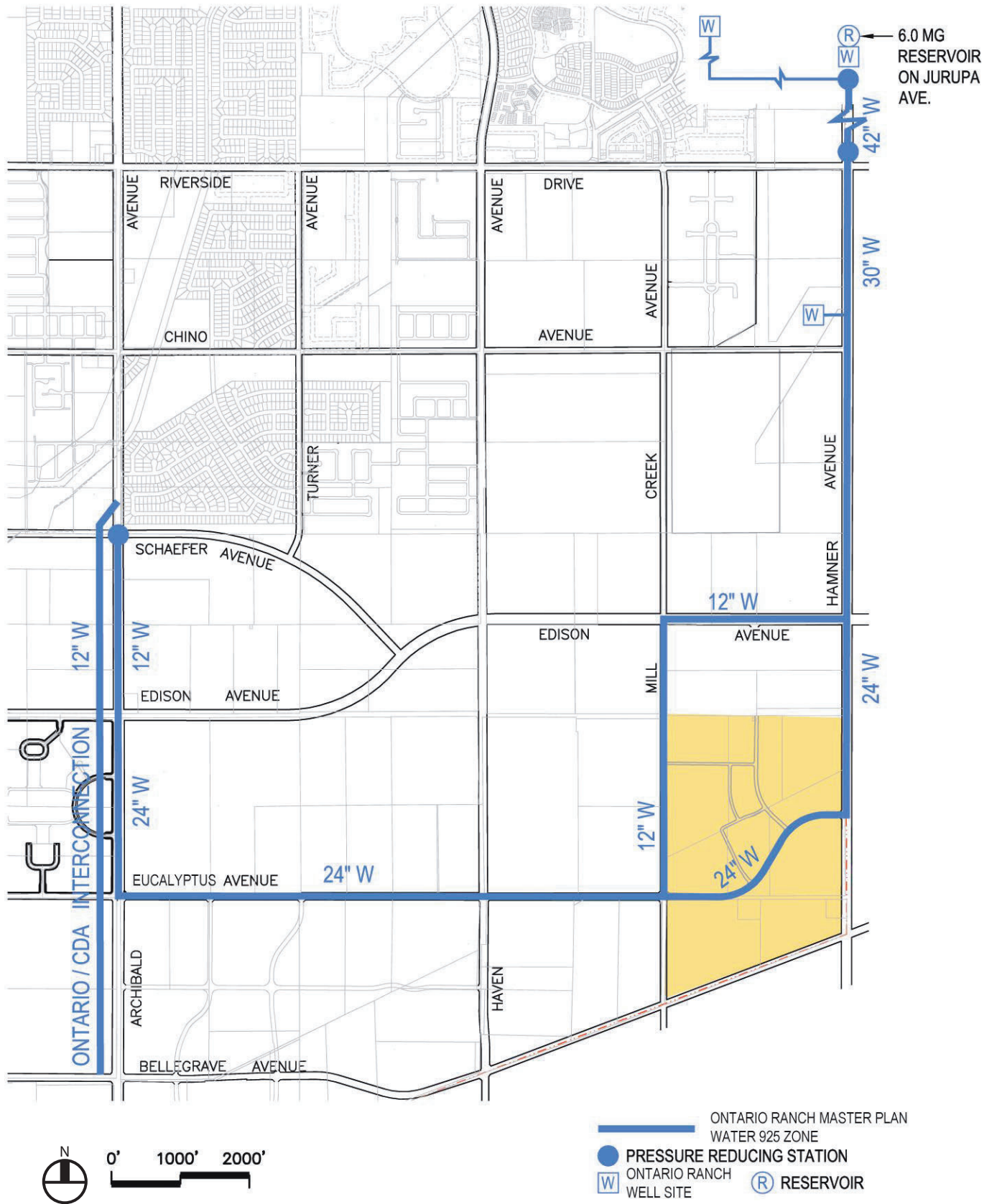
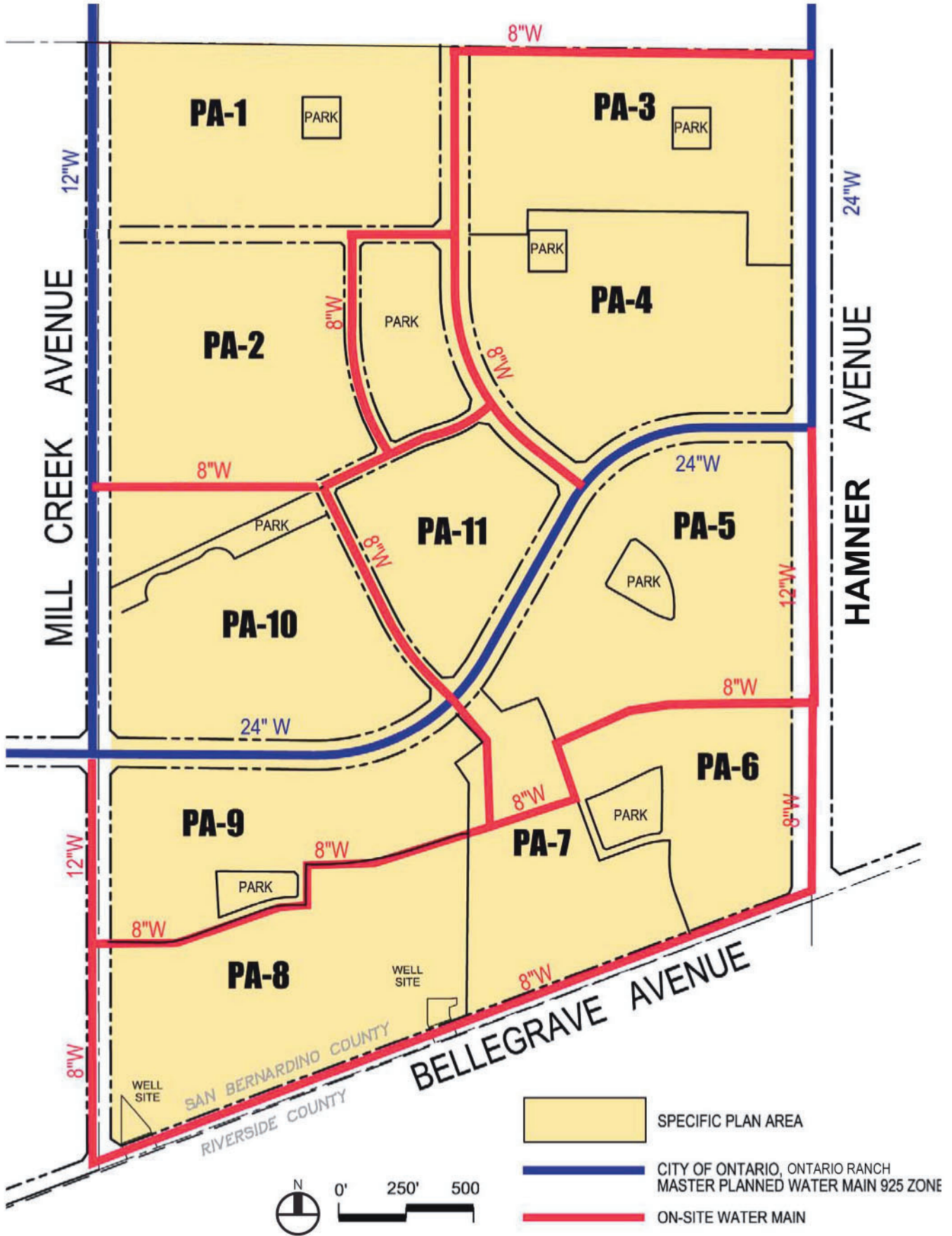

Exhibit 22
Conceptual Domestic Water Master Plan



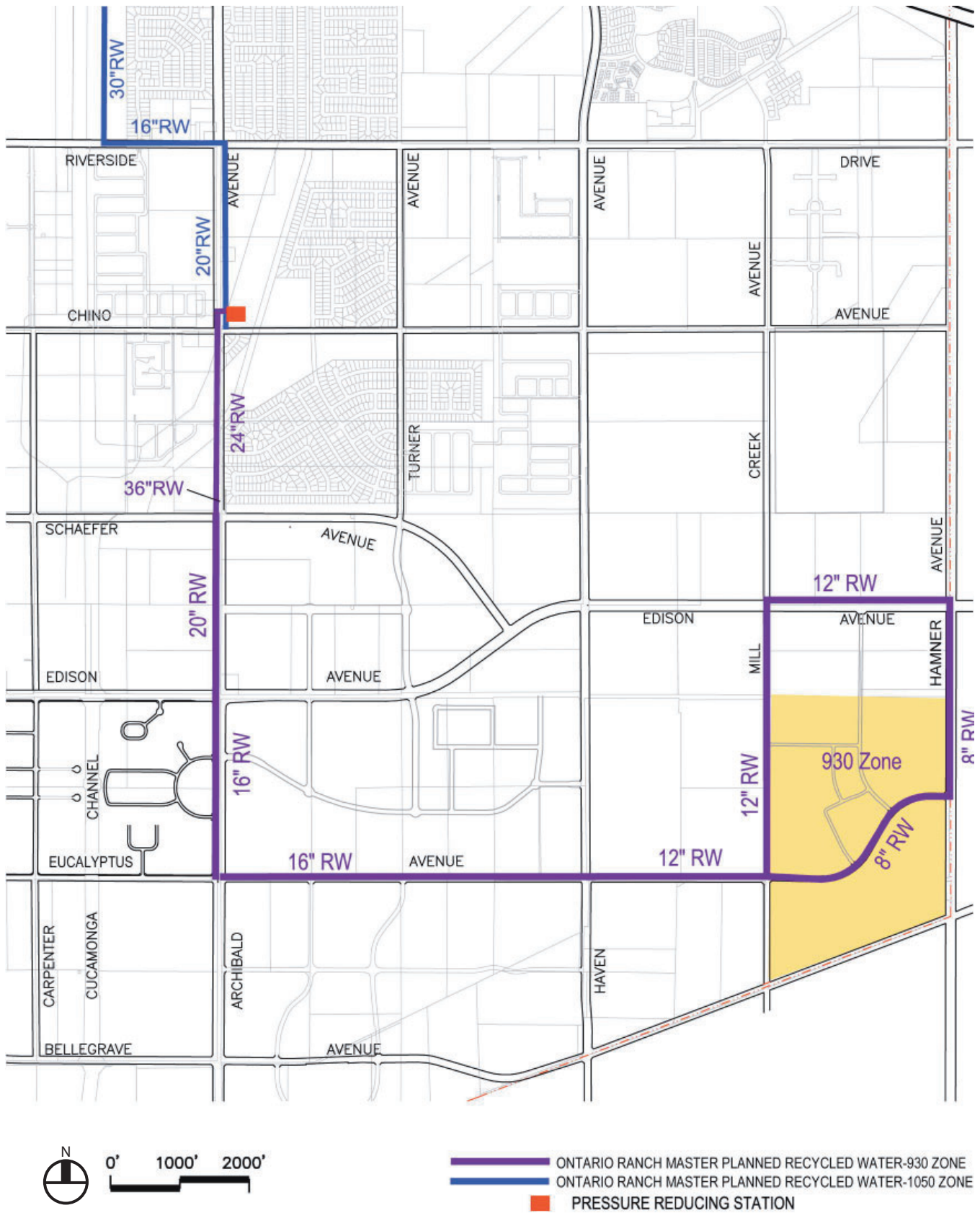
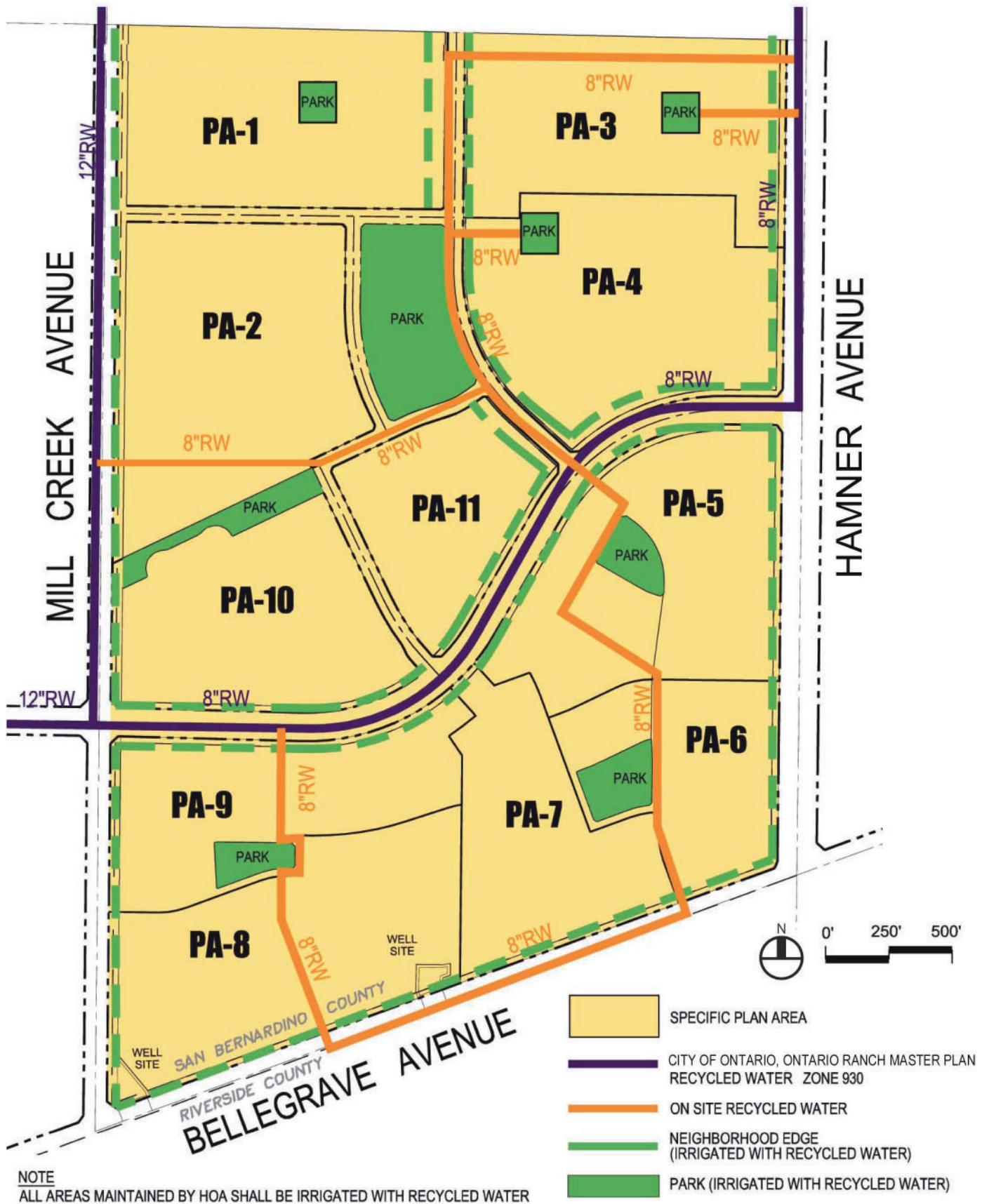
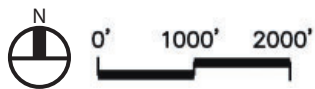
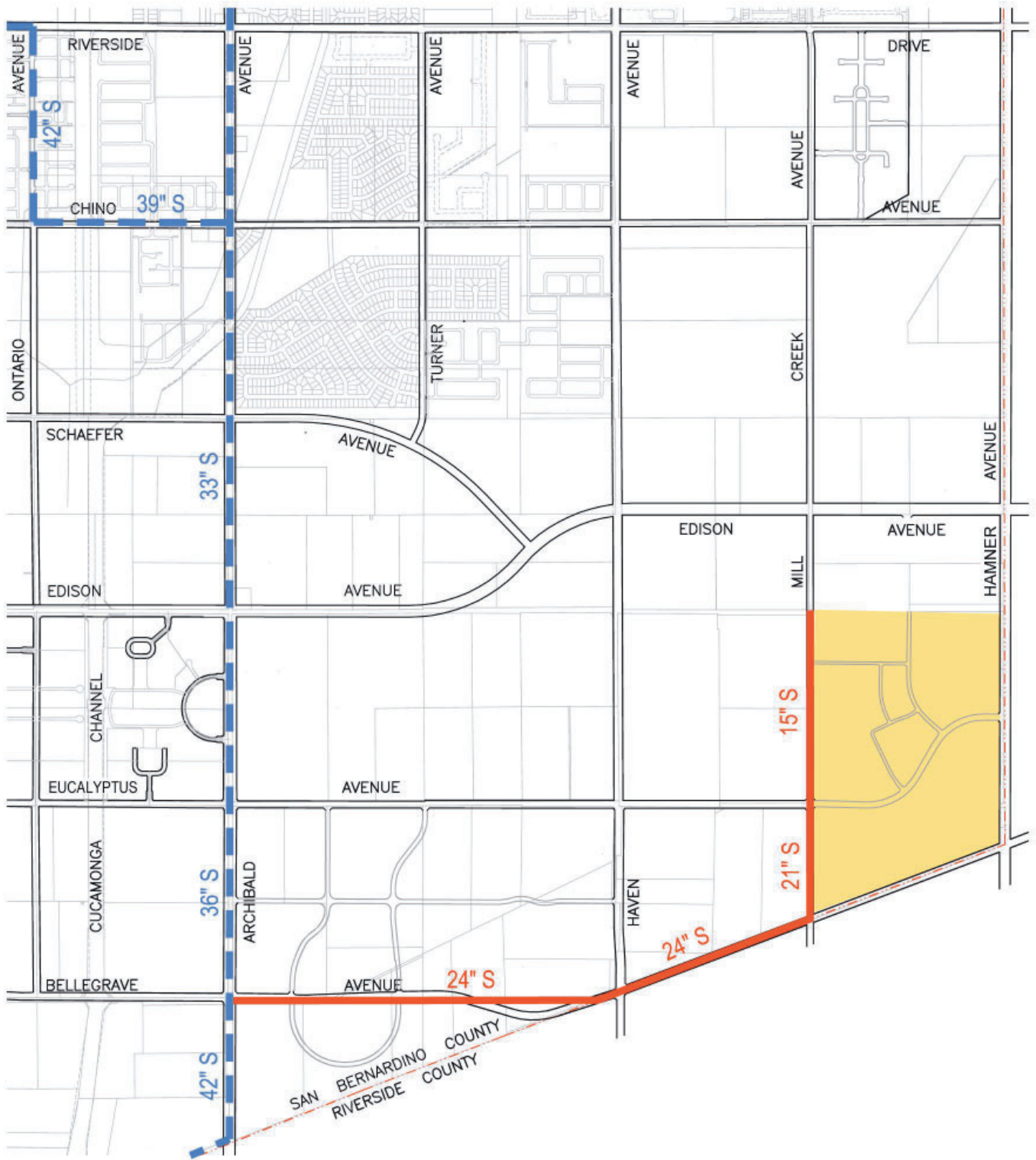

Exhibit 24
Conceptual Recycled Water Plan





- CITY OF ONTARIO, ONTARIO RANCH MASTER PLANNED SEWER MAIN
- - - EXISTING EASTERN TRUNK SEWER JOINTLY OWNED BY THE CITY OF ONTARIO AND THE INLAND EMPIRE UTILITIES AGENCY

Exhibit 26
Sewer Master Plan

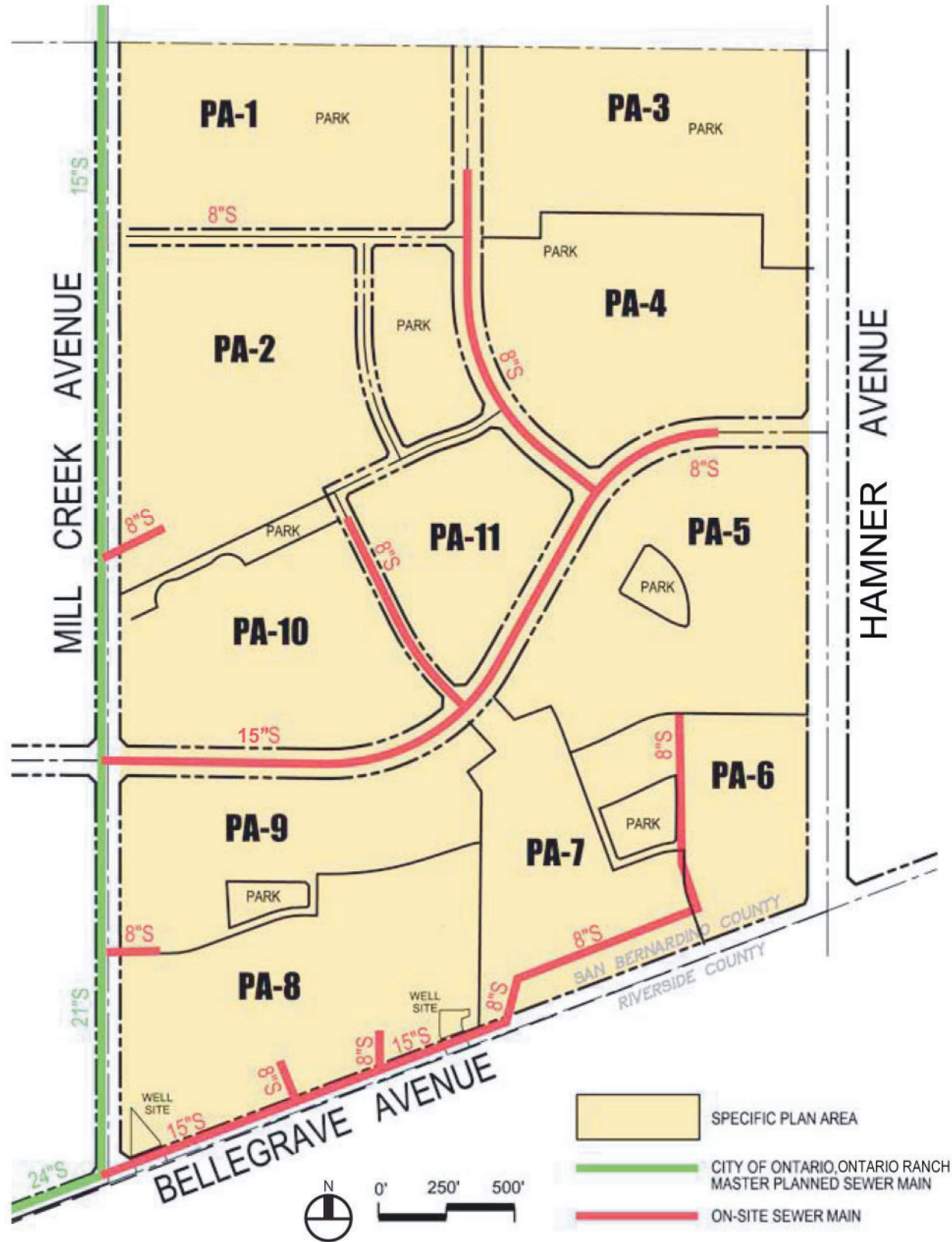

Exhibit 27
Conceptual On Site Sewer

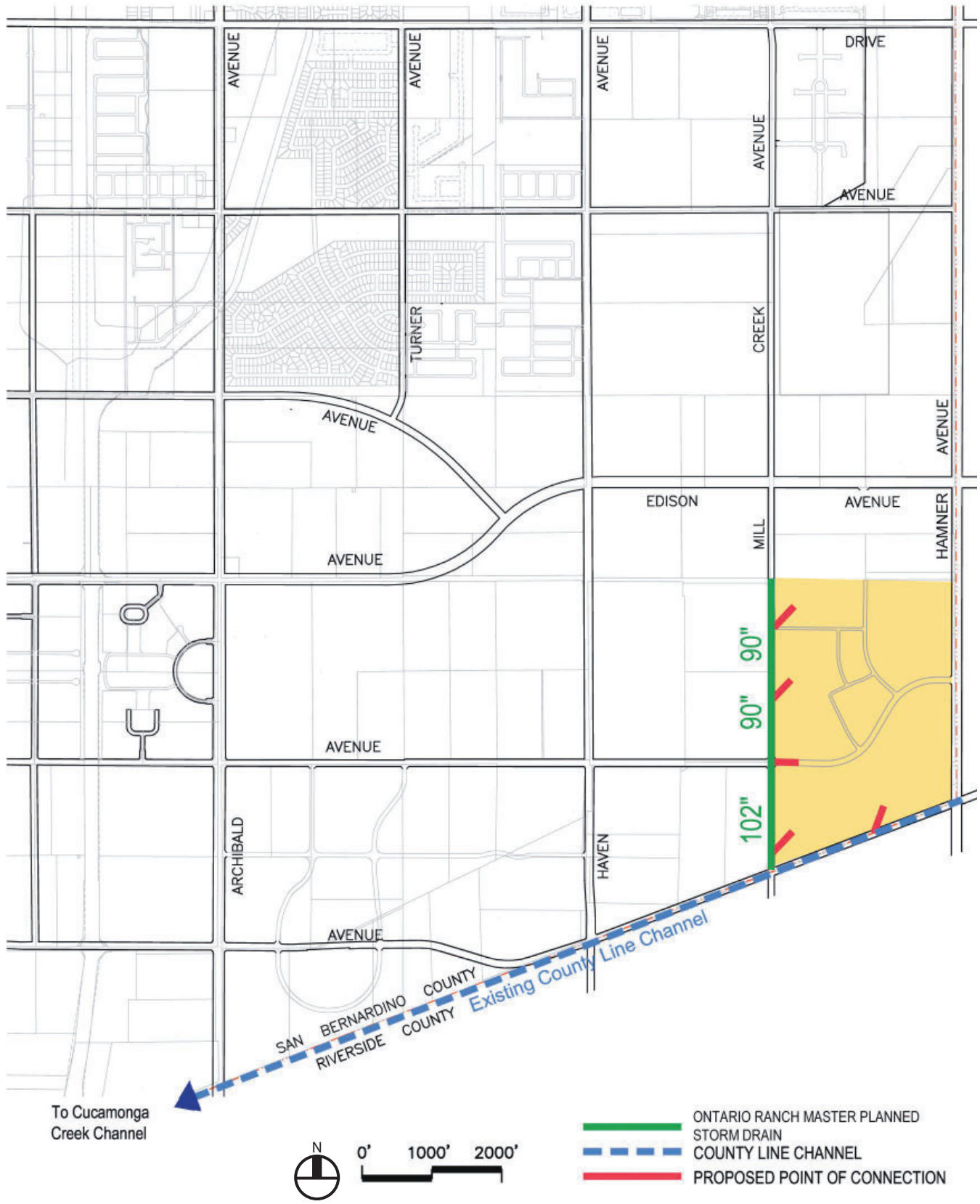

Exhibit 28
Storm Drain Master Plan

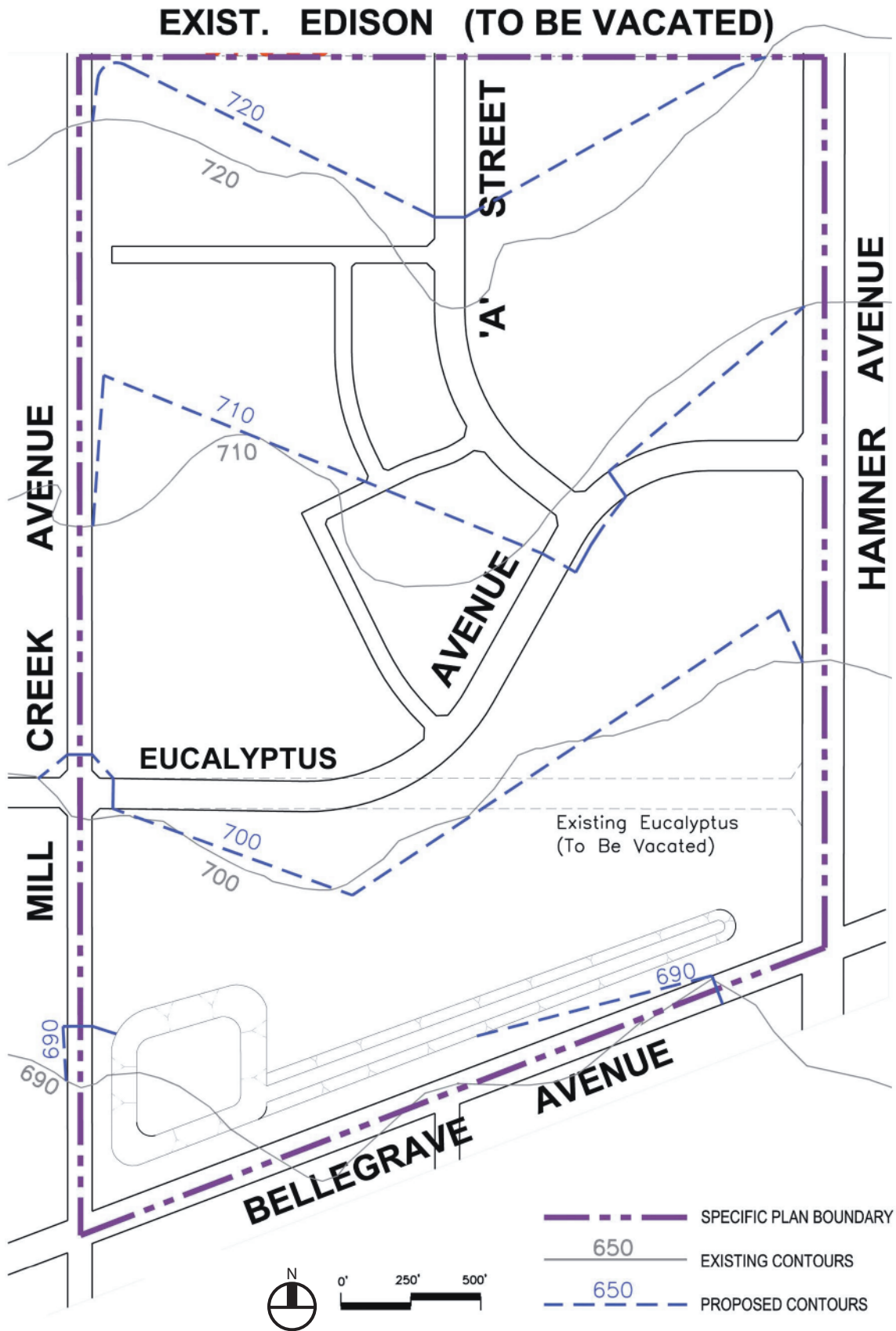

Exhibit 29
Conceptual Grading Plan

Endnotes

- 1 Updated table
- 2 Updated language per Engineering
- 3 Updated language per OMUC.
- 4 Updated language on WQMP
- 5 Updated sidewalk/granite trail